

Technology innovation of dryer machine based on sustainability automation systems to increase agel fiber production in handicraft SME

Khakam Maruf^{1,2}, Rizal Justian Setiawan^{2,3,8*}, Darmono⁴, Syukri Fathudin Achmad Widodo², Sumantri Sri Nugroho⁵, Nur Evida Khosyati⁶, Nur Azizah⁷

¹Industrial Engineering, Faculty of Engineering, Gadjah Mada University, Indonesia

²Mechanical Engineering Education, Faculty of Engineering, Yogyakarta State University, Republic of Indonesia

³Industrial Engineering and Management, College of Engineering, Yuan Ze University, Taiwan (R.O.C)

⁴Civil Engineering and Planning Education, Faculty of Engineering, Yogyakarta State University, Indonesia

⁵Balai Pengembangan Teknologi Tepat Guna (BPTTG), Disperindag DI, Yogyakarta, Indonesia

⁶Culinary Technology Education, Faculty of Engineering, Yogyakarta State University, Indonesia

⁷International Public Health, School of Public Health, China Medical University, Taiwan (R.O.C)

⁸Asia and China Studies, School of Law and Politics, National Chung Hsing University, Taiwan (R.O.C)

*Corresponding author E-mail: rizaljustiansetiawan99@gmail.com

(Received 17 April 2024; Final version received 25 December 2024; Accepted 24 January 2025)

Abstract

In Indonesia, natural fibers are extensively utilized as essential raw materials for various human needs. These natural fibers find significant application in handicrafts, particularly in small and medium enterprises (SME) within the handicraft industry. Agel, a prominent natural fiber, is obtained from drying gebang leaves and plays a vital role in the local economy of the Kulon Progo region in Yogyakarta, Indonesia. Currently, the production process of raw materials to become fiber relies on conventional methods, primarily sun-drying, which often gives rise to numerous challenges such as temperature fluctuations and weather dependencies. Moreover, the physical posture adopted by workers during the drying process is ergonomically unfavorable, as they must bend over repeatedly to turn the agel fibers being dried under the sun. After recognizing these issues, it becomes imperative to develop a sustainable dryer machine equipped with advanced technology that enhances productivity while prioritizing employee ergonomics. This study employs the research and development (R&D) method, which encompasses analysis, design, development, implementation, and evaluation stages. The primary objective of this research is to design, fabricate, and test a dryer machine utilizing a sustainability automation system integrated with Internet of Things (IoT). The outcome of this research is a dryer machine that can effectively dry agel leaves within a significantly reduced timeframe of 2–4 hours, with a maximum capacity of 10 kg per cycle. This achievement surpasses the conventional method, which typically takes 5–6 days to produce 10 kg of dried agel fibers.

Keywords: Agel Fiber, Crafts, Dryer Machine, Gebang Leaves; SME

1. Introduction

Indonesia is a country that is rich in natural biological resources to be utilized (Edy, 2023), Indonesia's natural resources and its ecosystem have an important

position and role to be utilized for life and national development (Albert et al., 2022; Nikijuluw, 2017). One of Indonesia's biological riches is plants that produce natural fiber. Natural fibers have many benefits and are widely used as raw materials needed by humans (Islam

& Mohammad, 2016; Marian et al., 2022). The need for natural fiber raw materials in Indonesia is quite high, this is proven by data on the value of imports of raw materials. Natural fibers are usually used as crafts, alternative additional materials, or as composite reinforcement (Kumar & Sekaran, 2014). Using natural fiber plants is considered more economical, easy to apply, corrosion resistant, and easy to obtain (Ali et al., 2021; Mochane et al., 2019; Zwawi, 2021). Along with the development of science and technology, the demand for natural fiber raw materials is increasing (Nurhaliza et al., 2023).

Agel fiber is a type of natural fiber that comes from the gebang leaves with the Latin name *Coryphatan* (Nugroho et al., 2018). The agel fiber is a promising natural fiber from the gebang plant with several advantages (Nuryanta et al., 2023). In Indonesia, this type of fiber is widely processed into various types of creative crafts, such as bags, decorations, wallets, and hats. In the process, agel fiber comes from raw gebang leaves which must go through 5 stages before it is ready to be woven. The initial stage is separating the stick from gebang leaves, then brushing to reduce the size, drying, dyeing, and finally being woven into raw material for crafts. The stages in the production of agel fiber raw materials are still using conventional methods.

The handicraft industry from agel fiber is one of the economic sectors driving local communities in the Sentolo District area, Kulon Progo, Yogyakarta (Widodo et al., 2020). Handicrafts made from agel fiber have an export target and are one of the products with quite high market interest. One of the agel fiber craft processing enterprises is located in Giling Hamlet, Tuksono, Sentolo, Kulon Progo, Yogyakarta. If the weather conditions are favorable, every month the enterprise is able to process gebang leaves and produce 150 kg of agel with an average of 5 kg of agel every day, and with 150 kg of agel, it is able to produce 300 to 500 handicrafts for one month. The average income earned for 1 month is IDR 9,000,000 or USD 591 (Exchange Rate USD 1 = IDR 15,227.24 on 10 August 2023). The raw material production process is still conducted conventionally by relying on sunlight, which often causes various problems, such as weather conditions, ergonomics issues, and longtime processes.

Working position and attitude during the drying process also has an unhealthy impact on body posture because when drying the workers must bend over to turn the agel that is being dried in the sun. The posture at work will indirectly change the shape and position

of the spine or cause injury and musculoskeletal disorders (MSDs) (Arnau et al., 2023; Bonfiglioli et al., 2022; Caponecchia et al., 2020). MSDs are disorders of the musculoskeletal system that are experienced by a person ranging from mild complaints to very painful (Irwan et al., 2023). If the muscles receive a static load in the long term, it will cause complaints in the form of damage to joints, ligaments, muscles, and other skeletal systems. Musculoskeletal disorders are one of the most common health problems experienced by workers (Kim, 2022; You et al., 2020).

Based on these problems, the researchers created Technology Innovation of Dryer Machine based on Sustainability Automation Systems to Increase Agel Fiber Production in Handicraft SMEs. The drying machine shortens the drying time of agel, which is 2–4 hours. The machine can also be used to dry agel fiber after the coloring process. This step makes it easier to produce agel fiber into handicrafts. The application of this machine makes the work position healthier because SME workers no longer must bend over to dry and turn the gel that is dried in the sun, this will be a solution in reducing the risk of MSDs.

The existence of an agel drying machine will help SME in increasing production without being constrained by the drying process, and their turnover is increasing compared to the conventional drying process with solar heat. The dryer machine has a monitoring system for temperature, humidity and drying time that has been integrated with an application on a smartphone so that the drying process of agel fiber can be monitored regularly. The application of the drying machine is expected to optimize the craft industry sector which can make SME businesses develop into sustainable businesses.

2. Literature Review

2.1. Relevant Previous Research

In this research, the fuel source uses liquefied petroleum gas (LPG). This was chosen based on conditions where LPG is easy to obtain and affordable to use in Indonesia. This system uses LPG as a heat source that is more controllable and uniform compared to drying using charcoal or solar power. Test results showed that this system has an energy efficiency of up to 90% and an exergy efficiency of up to 10%. This shows that this system effectively utilizes LPG gas input energy for the drying process (Benjamin et al., 2022). Apart from that, the drying system using LPG is more

efficient than conventional drying systems (Saparudin et al., 2021).

The second research obtained a recirculated batch-type corn drying machine with a capacity of 2 tons of corn per 8 hours. This machine uses a direct heating system with LPG fuel. Machine trials showed good performance with a drying rate of 1.55%/hour, heating efficiency of 92.03%, and drying efficiency of 88.96%. Overall, the test results showed that the design of the drying machine using LPG gas is quite optimal for drying corn on a production scale (Karyadi, 2019).

The research conducted is supported by several previous studies, where several studies that have been conducted state that electricity-based drying systems can increase the production of a business. In research conducted by Lasano (2018) stated that the use of microwaves for drying is an alternative drying method. This drying method is classified as efficient in terms of energy and time usage and is affordable. In another study, Karadag (2016) stated that materials heated with a microwave gave better results with a shorter process. Furthermore, according to research by Mihai (2016), the use of a drying machine can provide time effectiveness in increasing the productivity of the drying process to produce water hyacinth crafts.

Based on other research conducted by Radzuan (2020), on a kenaf leaf drying machine, data obtained for the drying process of kenaf leaves requires a temperature of 90–120°C. Given that the characteristics of gebang leaves and kenaf leaves are almost the same, but agel has a lower moisture content, we use this research as a reference for the temperature used in the drying machine oven, which is around 75–85°C.

2.2. Research Thinking Framework

In this framework of research thinking, the stages are explained starting from the analysis of the problems experienced by many Small Medium Enterprises (MSMEs) in the agel craft industry, namely the process of drying raw materials. This research was conducted from the development of its first version under the name Agel Dryer Machine. In the application of the first device, several shortcomings were still found related to machine use problems experienced by an SME and this became the background for further research. It is hoped that with the development of this second version of research, the resulting device will be appropriate and more perfect than the first version so that it can meet the needs of an SME in the agel craft

industry. The next stage is to develop alternative ideas for solving the problem in the form of an innovation, an appropriate technological machine for the agel drying process so that it can produce benefits for an SME. The stages of solving this problem include designing a new device by combining the concept of appropriate technology, a monitoring system and safety for the gas regulator section. Internet of Things (IoT) is developed and used in the system to make it easier for users to control and monitor devices via a smartphone (Setiawan et al., 2024). The framework of thinking used in the research is shown in Fig. 1.

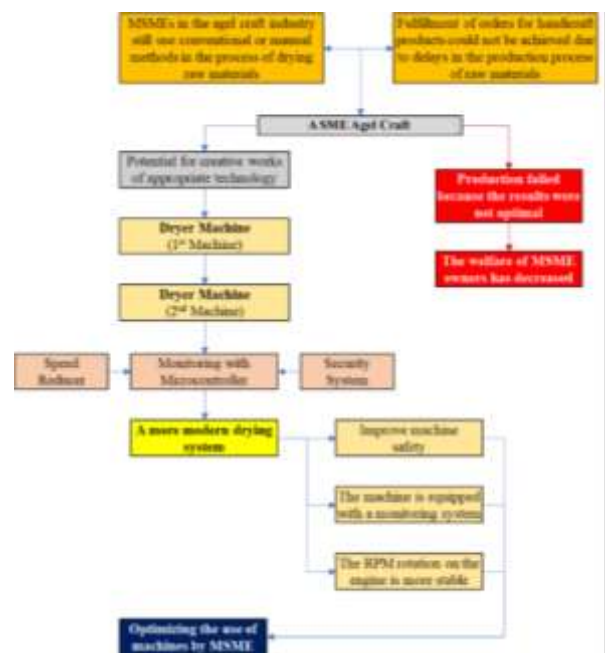

Fig. 1. Research thinking framework

3. Research Methodology

This study used the Research and Development (R&D) method, which is a research method to produce certain products and test the effectiveness of the products (Ma'ruf et al., 2024; Setiawan et al., 2021). This method is combined with the ADDIE model.

The machine development procedure applies to the ADDIE model which consists of five process stages including analysis, design, development, implementation, and evaluation (Salas-Rueda et al., 2020). The evaluation stage is used to determine the feasibility of the machine and the final stage of refinement (Chen & Setiawan, 2023). The initial stage is an analysis of the potential problems that are still being experienced from the application of the initial product. This ADDIE model research has several steps so that it becomes a machine that is ready for use. The flow of the

stages of the research process is conducted as shown in Fig. 2.

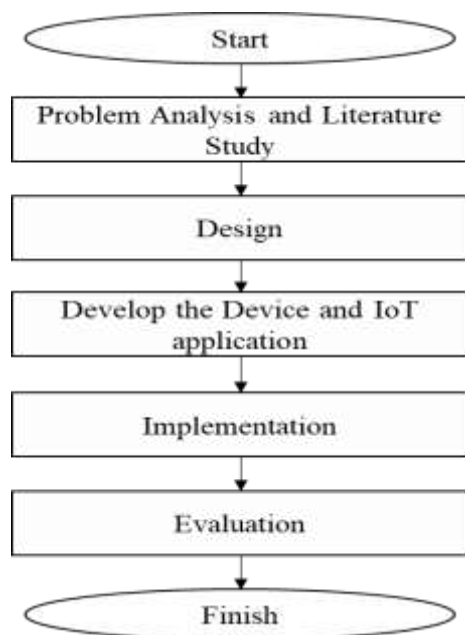

Fig. 2. Research and development (R&D) stages based on ADDIE model

4. Results and Discussion

4.1. Drying Method Comparison

Currently, many SMEs continue to rely on conventional methods using sunlight for drying agel fiber. Unfortunately, this approach often leads to sub-optimal drying times, lengthy processes, and significant susceptibility to weather-related factors. As a result, our partners encounter a range of obstacles in the production of agel fiber craft materials.

In Fig. 3, there are drying steps using conventional methods. The main problem is during the drying process, this process takes 4 to 5 days. Additionally, additional time is required if weather conditions are not in clear condition.

To address this challenge, it is clear that the development of appropriate technological innovations is necessary. Fig. 4 shows a drying machine that has been developed.

Fig. 5 shows the framework of the drying step using a machine. The steps involved are fewer than those in the conventional method.

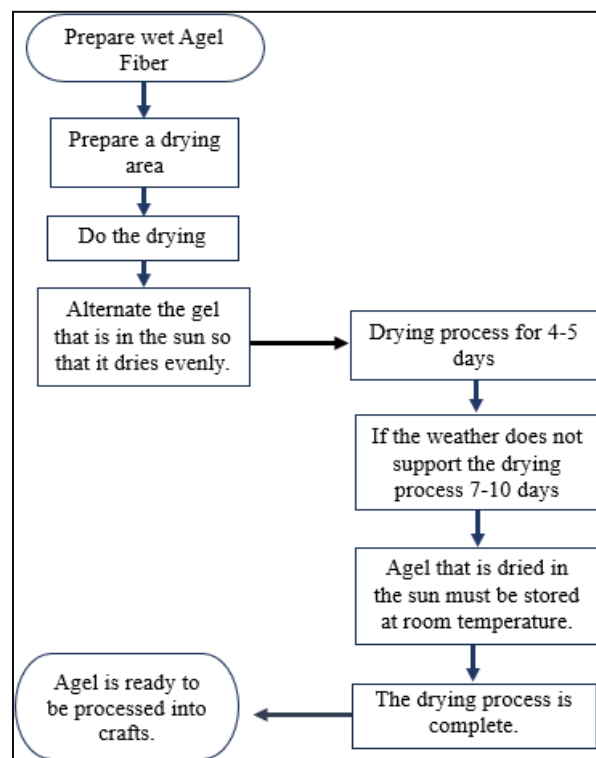

Fig. 3. Drying stage with conventional method



Fig. 4. Implementation of a drying machine

4.2. Product Specifications

Table 1 describes the specifications for the dryer machine, which has dimensions of 150 cm × 80 cm × 100 cm with a maximum production capacity of 10 kg. The materials used include the type of material for the frame, namely mild steel elbow 3 × 3 cm and mild steel plate with a thickness of 1.2 mm as material for fiber drying tube and machine cover. The power source for the machine's motor uses 900 VA home electricity. The source of the drying heat used is from an LPG stove with a temperature of 75–85°C. Based on testing on the drying machine that the researchers conducted

with the 10 kg gebang leaves using the temperature of 75–85°C for 4 hours, the gebang leaves were dried and not burnt as much as 7.5 kg.

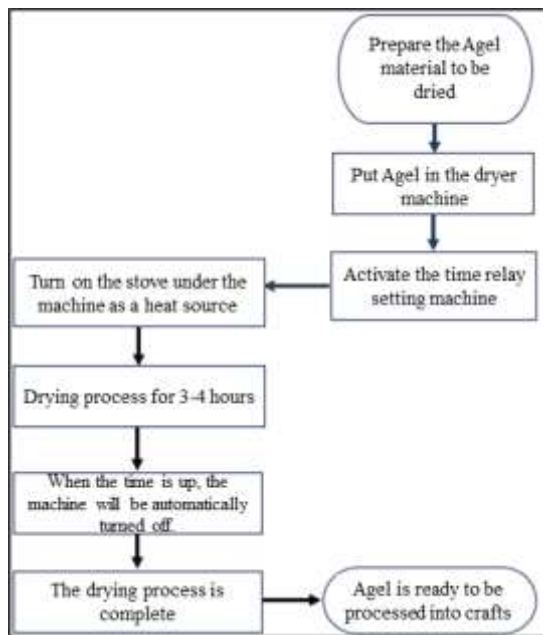

Fig. 5. Drying stage with machine

Table 1. Dryer machine specifications

No	Specification type	Information
1	Machine size	150 cm × 80 cm × 100 cm
2	Machine capacity	10 kg
3	Machine frame material	Mild steel elbow 3 × 3 cm
4	Drying tube material	Mild steel plate 1.2 mm
5	Drive mechanic	Electric motor ½ Hp
6	Heat source	LPG Stove
7	Monitoring system	IoT and application
8	Motor RPM	23.3 RPM
9	Power source for motor	Grid electricity 900 VA

4.3. IoT System and Monitoring on Drying Machine

4.3.1. IoT Implementation on Drying Machine

Apart from using an analog thermometer as a conventional temperature meter. The drying machine also uses a temperature sensor supported by the IoT to be able to monitor temperature with a smartphone. The

dryer monitoring system uses a temperature sensor placed inside the processing tube to detect the temperature of the air.

The circuit needs a power supply of 12 V DC electricity, stabilized with a step-down of 9 V, for the system to function. This ensures that the microcontroller receives the required power supply of 9 V. Once the power supply is on, the microcontroller and temperature sensor are activated. The circuit then looks for connectivity with the nearest Wi-Fi module that has been previously programmed. The connection between the circuit system and IoT is established through oven monitoring applications. Fig. 6 displays the IoT electronic circuit in the drying machine.

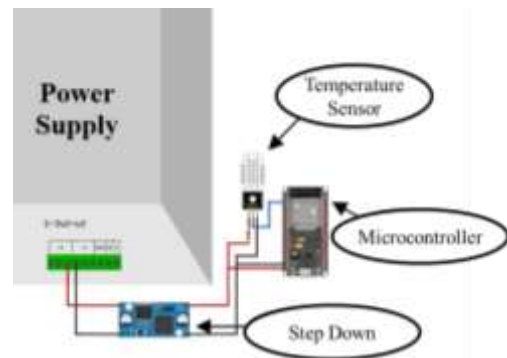

Fig. 6. IoT system electronic circuit

The temperature sensor will measure temperature values and convert them into digital signals. The digital signal from the temperature sensor will be read by the microcontroller. The microcontroller will transmit temperature and humidity data from the temperature sensor via the WiFi network to the cloud server. Temperature data that has been sent to the cloud will be stored in the server database in the application system.

Monitoring system administrators can view the current conditions of oven temperature and humidity via a web dashboard or smartphone application connected to the server. If the temperature or humidity of the oven exceeds the specified normal limits, the system can provide a warning in the form of a notification on the monitoring dashboard. Oven operators can immediately recognize abnormal conditions and take necessary action. By implementing this cloud-based IoT system, temperature and humidity in the oven can be remotely monitored without the need to physically

visit the oven location. The monitoring process becomes more efficient and effective.

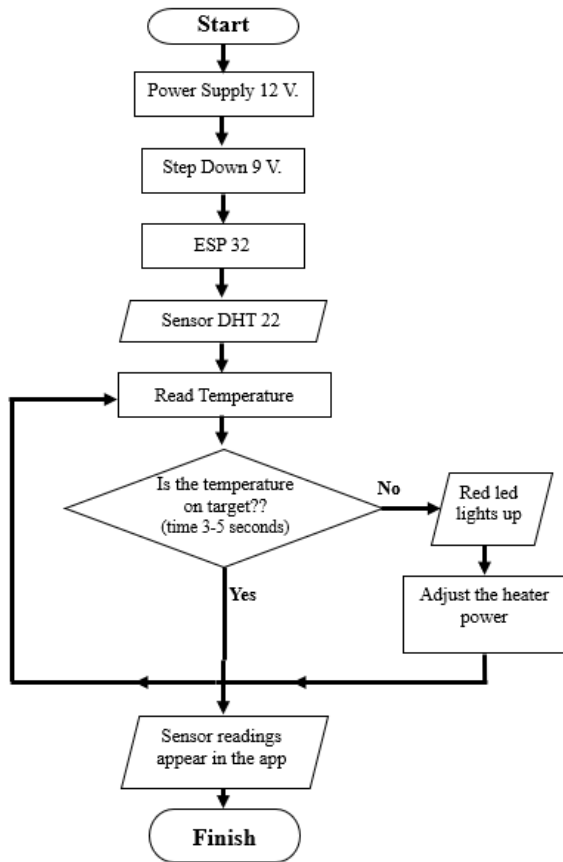

Fig. 7. Drying machine IoT working scheme

Fig. 7 explains the diagram of how the IoT system works and the use of the agel fiber drying machine, the initial stage of the machine's work starts from the process. The system is activated with a 12 V power source, the voltage is reduced to 9 V using a step-down converter to supply the microcontroller ESP 32, the temperature sensor DHT 22 is connected to the microcontroller to monitor the drying room temperature. The microcontroller reads temperature data from the temperature sensor periodically. If the temperature is detected to exceed the specified limit, the red LED will light up as a warning indicator. Temperature reading data from the sensor is displayed on an application connected to the microcontroller, enabling remote monitoring. This automation system allows precise temperature setting and control on the drying machine, increasing the efficiency of agel fiber production in an environmentally friendly way.

4.3.2. Monitoring Applications

The application created from the kodular.io web is then extracted into Apk format so that it will become an application that can later be installed on the user's smartphone. The application display form can be seen in Fig. 8. This application has been programmed and connected to the sensor and microcontroller. Before entering the application monitoring system, users are asked to enter the username and password that they previously created, to ensure that application security and integration are more focused on connection.

At this stage, the application is only in the first stage of development, so a deficiency was found where the application had a delay of 2–3 seconds for sensor reading and data transmission. This factor was also caused by the type of microcontroller used. Research for monitoring systems has not yet reached the perfect phase so it needs to be further improved regarding the electronic components used. In this application there is a menu to periodically recap production results.

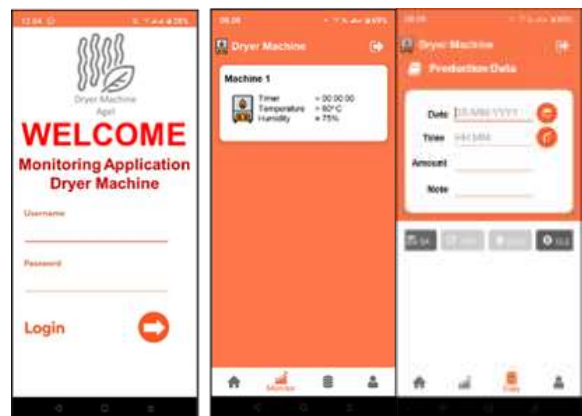

Fig. 8. Display of application monitoring dryer machine

4.4. Dryer Machine Operation

The dryer machine works from the initial stage of inserting the wet gebang into the processing tub and then closing the machine until the final stage of the drying process is complete. Fig. 9 shows a drying machine turning wet gebang leaves into dried agel fiber.

The steps to use the Agel Dryer Machine are as follows:

- 1) The dryer machine works from the initial stage of inserting the wet gebang into the processing tank.

- 2) Then, close the machine processing tub, at this stage make sure the processing tub lock is completely closed.
- 3) The next stage is activating the machine and setting the time relay. At this stage, the monitoring process will also function, then the application is opened.
- 4) After the engine starts to rotate, turn on the engine heating stove.
- 5) Wait for the drying process for 2–2.5 hours.
- 6) The machine will turn off automatically according to the timer that has been previously set.
- 7) After the process is complete and the fiber has dried as shown in Fig. 11, take out the fiber and remove it from the processing tube.

Fig. 10 shows the first stage when the dryer machine tank is opened by the user.



Fig. 9. Overall view of the dryer machine



Fig. 10. Opening of the dryer machine tank



Fig. 11. Dryer machine tank with the dried fiber

4.5. Implementation Result

The experiments using this machine were with capacities of 5 kg, 7.5 kg, and 10 kg. In this experiment, wet gebang leaves were able to dry for 2 hours, 3 hours, and 4 hours by maintaining the machine temperature between 75°C and 85°C. Fig. 12 presents the state of gebang leaves before and after the drying process to produce agel fiber, and the usage of the fiber to make handicrafts.

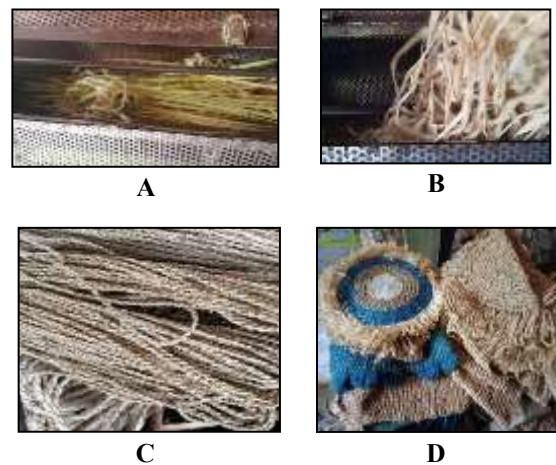

Fig. 12. Production of agel fiber from gebang leaves and handicraft making using the fiber. (A) Wet gebang leaves; (B) Dried gebang leaves; (C) Agel fiber from dried gebang leaves; (D) Agel fiber being made into handicrafts.

Fig. 12A–D show the images of processing wet gebang leaves into agel fiber and the making of handicrafts using the fiber. Fig. 12A shows the fresh and wet gebang leaves, which have a bright green color with a soft texture. It can also be seen that the leaves are still intact and have not dried out.

Fig. 12B shows gebang leaves that have been dried by the machine. The color of the leaves changes to brown after going through the drying process. The texture becomes stiffer and brittle compared to wet gebang leaves.

Fig. 12C demonstrates agel fiber from dried gebang leaves. In this image, there are results of agel fiber assembled from dried gebang leaves. This agel fiber has the appearance of a fine thread or rope and is brownish. This fiber is produced through a special processing process from dried gebang leaves.

Fig. 12D shows the usage of agel fiber for making handicrafts. The agel fiber is woven or knitted into various handicraft products, such as bags, hats, or other webbing. There are distinctive motifs and textures of agel fiber combined with the creativity of craftsmen.

Data related to machine testing, including time and dryer machine temperature, are presented in Table 2.

Table 2. Dryer machine testing result

Testing	Time (minutes)	Dryer machine temperature
1st Test (Capacity 5 kg wet gebang leaves)	0	23
	30	46
	60	63
	90	84
	120	83
2nd Test (Capacity 7.5 kg wet gebang leaves)	0	23
	30	46
	60	63
	90	83
	120	82
	150	81
3rd Test (Capacity of 10 kg wet gebang leaves)	180	84
	0	25
	30	49
	60	65
	90	84
	120	83
	150	84
	180	84
210	84	
	240	85

The final data of the research testing results reaches the research conclusions. It is known that the maximum weight of the wet gel used in the test is 10 kg. The drying temperature in the sun is between 25°C and 35°C or uncertain for 8 hours per day. Meanwhile, 10 kg of agel that is dried using a dryer machine is set at a temperature of 75–85°C and can dry in 4 hours. The water content of dried gebang leaves has an

average water content of 65%. Dried gebang leaves that have been processed by machine or called agel fiber have a dryness of 13–15%, with the water content in the fiber measured using the Amtast MC-7806 measuring instrument. The results related to the comparison can be seen in Table 3.

Table 3. Dryer machine specifications

No	Type of drying	Temperature	Amount	Drying time
1	Conventional method	25–35°C	10 kg (one drying)	40 hours (8 hours/day if sunny)
2	Dryer machine	75–85°C	10 kg	4 hours

4.6. Result of Dried Agel Production

Calculations were conducted regarding the agel production after implementing the drying machine for 1 month of production to determine the increase in SME productivity before and after using this machine. This machine is capable of drying wet gebang leaves in one process with a maximum capacity of 10 kg, then craftsmen can get an average of 7.5 kg of dried agel fiber. Accumulatively, the conventional method is only able to produce 45 kg of dried agel fiber by one worker with 8 hours per day for one month (30 days) and under favorable weather conditions, whereas when using a dryer machine, it can produce 225 kg of dried agel fiber with continuous 24-hour operation, irrespective of weather condition.

5. Conclusion

The study has successfully manufactured and implemented a drying machine that uses IoT system monitoring to address partner problems related to monitoring the agel fiber drying process. This system is equipped to monitor the drying process at features such as temperature, humidity, remaining time, and drying mark completion, and can function optimally according to the work method that has been designed. The dryer machine has dimensions of 150 cm × 80 cm × 100 cm and a production capacity of 10 kg. It features a 3 × 3 cm angle iron frame and a laser plate as part of its engine cover with a thickness of 1.2 mm. The machine uses 900 VA house electricity as its energy source for motor and an LPG gas stove with a temperature of 75–85°C as its drying heat source. With this machine, 10 kg of wet gebang leaves can be dried in 4 hours, producing 7.5 kg of dry agel, resulting in a

production of 225 kg per month. This machine creates a significant improvement compared to the conventional method that previously took 5–6 days to produce 10 kg of dried agel and was only able to produce 50 kg each month. By using this machine, the drying process becomes easier and the risk of MSDs due to inappropriate body posture while working can be reduced.

Acknowledgments

The authors would like to thank PT. Engineer Tech Indonesia and CV. Inanri Sukses Bersama for supporting this work.

References

- Albert, R., Sunardi, & Joko, S. (2022). Legal Protection of Biological Resources and Its Ecosystems in Indonesia. *Journal Social Science Research Network (SSRN)*, 1–16.
- Ali M.J, Faris M. A., & Anas A.J. (2021). Transient Behavior of Non-Toxic Natural and Hybrid Multi-Layer Desiccant Composite Materials for Water Extraction from Atmospheric Air. *Environmental Science and Pollution Research*, 28, 45609–45618. <https://link.springer.com/article/10.1007/s11356-021-13995-3>.
- Altshuller, G.S. (1984). *Creativity as an Exact Science: The Theory of the Solution of Inventive Problems*. Gordon and Breach Science Publishers.
- Arnau, S.S., Asensio, Cuesta., S.A., & Seder, R. P. (2023). Musculoskeletal Disorders Risk Assessment Methods: A Scoping Review from a Sex Perspective. *Journal Ergonomics*, 1–20. <https://doi.org/10.1080/00140139.2023.2168767>.
- Benjamin, O.E., A., Stephen, A., Onyewuchi, E., & Uchenna, N. (2022). Design and Analysis of Energy and Exergy Performance of an LPG-Powered Fish Drying Machine. *Kejuruteraan*. 34(1),117–129. [https://doi.org/10.17576/jkukm-2022-34\(1\)-11](https://doi.org/10.17576/jkukm-2022-34(1)-11).
- Bonfiglioli, R., Caraballo, A., Y., & Salmen, N. (2022). Epidemiology of Workrelated Musculoskeletal Disorders. *Current Opinion in Epidemiology and Public Health Journal*, 1(1), 18–24.
- Caponecchia, C., Coman, R.L., Gopaldasani, V., Mayland, E.C., & Campbell, L. (2020). Musculoskeletal Disorders in Aged Care Workers: A Systematic Review of Contributing Factors and Interventions. *International Journal of Nursing Studies*, 110, 103715. <http://dx.doi.org/10.1016/j.ijnurstu.2020.103715>.
- Chen, Y.T., & Setiawan, R.J. (2023). Energy Saving Solution for Welding Process: A SME Case Study of Fume Extractor. *2023 IEEE 6th International Conference on Knowledge Innovation and Invention (ICKII)*, Sapporo, Japan, 2023, 720–725. <https://doi.org/10.1109/ICKII58656.2023.10332684>.
- Edy L. (2023). Excess of Natural Resources Exploitation on Health and Environment by Foreign Investors. *Proceedings of the International Conference on Law, Economics, and Health (ICLEH), ASSEHR*, 723(1), 712–726. https://doi.org/10.2991/978-2-38476-024-4_72.
- Irwan, Juwita S., Deliyana I., & Tirsia K.M. (2023). Analysis Of Work Duration and Workload With Complaints Of Musculoskeletal Disorders (Msds) On Laundry Workers In Duingingi District The City Of Gorontalo. *International Journal of Health Science & Medical Research*, 2(1), 115–124. <https://doi.org/10.37905/ijhsmr.v2i2.13565>.
- Islam, S., & Mohammad, F. (2016). Sustainable Natural Fibres from Animals, Plants and Agroindustrial Wastes—An Overview. *Sustainable Fibres for Fashion Industry*, 31–44. https://doi.org/10.1007/978-981-10-0566-4_3.
- Karadag, A., Nazmiye, A., Kasapoğlu, K.N., & Ozcelik, B. (2016). Effect of Microwave Technology on Some Quality Parameters and Aensory Attributes of Black Tea. *Czech Journal Food Sci*, 34(5), 397–405. <http://dx.doi.org/10.17221/5/2016-CJFS>.
- Karyadi, J., Hikam, F., Suganda, E., Muhklis, E., & Purwantana, B. (2019). Design of recirculated column dryer type for corn (*Zea mays* Linnaeus) drying. *IOP Conference Series: Earth and Environmental Science*, 365. <https://doi.org/10.1088/1755-1315/365/1/012034>.
- Kim, W.J., Park, H.J., & Jeong, B.Y. (2022). Article A Cross-Sectional Descriptive Study of Musculoskeletal Disorders (MSDs) of Male Shipbuilding Workers and Factors Associated the Neck. *Journal Applied Sciences*, 12, 3346. <https://doi.org/10.3390/app12073346>.
- Kumar, K., & Sekaran, A. (2014). Some natural fibers used in polymer composites and their extraction processes: A review. *Journal of Reinforced Plastics and Composites*, 33, 1879–

1892. <https://doi.org/10.1177/0731684414548612>.
- Lasano, N.F., Rahmat, A., Ramli, N.S., & Bakar, M.F.A. (2018). Effect of Oven and Microwave Drying on Polyphenols Content and Antioxidant Capacity of Herbal Tea from *Strobilanthes crispus*. *Asian Journal of Pharmaceutical and Clinical Research*, 11 (6), 363–368. <http://dx.doi.org/10.22159/ajpcr.2018.v11i6.24660>.
- Ma'rif, K., Setiawan, R. J., Darmono., Alam., A. A. K., Azizah, N., & Khosyati, N. E. (2024). Integration of Solar Photovoltaic System and Water Filter: A Sustainable Energy Solution for Clean Water Supply. *2024 International Conference on Electrical and Information Technology (IEIT)*, Malang. <https://doi.org/10.1109/IEIT64341.2024.10763095>.
- Maria W., Lusy & Ignatius R. (2022). Indonesian Kenaf Fiber Export Potential as A Raw Material For Various Industry. *International Journal of Economics, Business and Accounting Research (IJEBAAR)*, 6(1), 1980–1988.
- Mihai, B. (2016). How to use the DHT22 sensor for measuring temperature and humidity with the Arduino board. *ACTA Universitatis Cibiniensis*, 68 (1), 22–25. <http://dx.doi.org/10.1515/aucts-2016-0005>.
- Mochane, M.J., Mokhena, T.C., Mokhothu, T.H., Mtibe, Asanda, S., Ray E.R., Suprakas, S.I., & Daramola, I.D. (2019). Recent Progress on Natural Fiber Hybrid Composites for Advanced Applications: A Review. *CSIR Research Space*, 13, 159–198. <http://dx.doi.org/10.3144/expresspolymlett.2019.15>.
- Nikijuluw, V.P.H. (2017). Coastal Resources Conservation in Indonesia: Issues, Policies, and Future Directions. *Sumatra Journal of Disaster, Geography And Geography Education*, 1(1), 15–23. <https://doi.org/10.24036/SJDGGE.V1I1.31>.
- Nugroho, A., Abdurrohman, K., & Hestiawan, H. (2018, April). Effect of manufacturing method to tensile properties of hybrid composite reinforced by natural (agel leaf fiber) and glass fibers. In *Journal of Physics: Conference Series* (Vol. 1005, No. 1, p. 012004). IOP Publishing. <https://doi.org/10.1088/1742-6596/1005/1/012004>
- Nurhaliza, U.H., Centra, G., Anggoro, S.D., & Oktaviandri, M. (2023). Design and Analysis Rolling Press Mechanism for producing Banana Stem as Natural Fiber. *Journal of Sustainable Mechanical Engineering*, 1, 8–11. <http://dx.doi.org/10.54378/josme.v1i1.5604>.
- Nuryanta, M.I., Aryaswara, L.D., Korsmik, R., Korsmik, O.K., Nugraha, A.D., Darmanto, S., Kusni, M., & Muflikhun, M.A. (2023). The Interconnection of Carbon Active Addition on Mechanical Properties of Hybrid Agel/Glass Fiber-Reinforced Green Composite. *Journal Polymers*, 2411, 1–18. <https://doi.org/10.3390/polym15112411>.
- Radzuan, N.A.M., Tholibon, D., Sulong, A.B., Muhamad, N., & Haron, C.H.C. (2020). Effects of High-Temperature Exposure on the Mechanical Properties of Kenaf Composites. *Polymers*, 12(8), 1643. <https://doi.org/10.3390/polym12081643>.
- Salas-Rueda, R. A., Salas-Rueda, E. P., & Salas-Rueda, R. D. (2020). Analysis and design of the web game on descriptive statistics through the ADDIE model, data science and machine learning. *International Journal of Education in Mathematics, Science and Technology (IJEMST)*, 8(3), 245–260. <https://doi.org/10.46328/ijemst.v8i3.759>
- Saparudin, M.A., Setiawan, R.J., Budi, E., Puspito, A., & Fauzi, A. (2021). Design and Manufacture of Bamboo Handicraft Dryer Machine Based on LPG Gas. *Tadulako Science and Technology Journal* 2(1), 1–9. <https://doi.org/10.22487/sciencetech.v2i1.15555>
- Setiawan, R.J., Hidayat, H., Putra, P.P., Laksana, H.K., & Putra, P.I. (2021). Rancang Bangun Horizontal Gas Cutting Machine untuk Pemotongan Pipa. *Nozzle: Journal Mechanical Engineering*, 10(2), 34–44. <https://doi.org/10.30591/nozzle.v10i2.2572>.
- Setiawan, R.J., Ma'rif, K., Suryanto., I.D., Azizah, N., & Khosyati, N.E. (2024). Development of Rescue Drone integrated with Internet of Things Control for Beach Surveillance-Case Study at Glagah Beach. *International Conference on Electrical Engineering, Computer Science and Informatics (EECSI)*, 603–608. <https://doi.org/10.1109/EECSI63442.2024.10776458>
- Widodo, Suparmin., Alfat K., & Basroni, A.N. (2020). Mapping Skill and Workplace Human Resources Leading Innovative Products Natural Fiber Vocational Village in Tuksono, Sentolo, Kulon Progo. *International Seminar Commemorating The 100th Anniversary of*

Tamansiswa, 1, 480–484.

You, W.S., & Jeong, B.Y. (2020) Work-related accidents and illnesses of older shipbuilding workers. *Journal of the Ergonomic Society Korea*, 39, 205–211.

<http://dx.doi.org/10.5143/JESK.2020.39.3.205>.

Zwawi, M. (2021). A Review on Natural Fiber Bio-Composites, Surface Modifications and Applications. *Journal Molecules*, 26, 1–28. <https://doi.org/10.3390/molecules26020404>.

AUTHOR BIOGRAPHIES



Khakam Ma'ruf. He obtained his B. Ed in Mechanical Engineering from Yogyakarta State University. Now, he is a student in the Industrial Engineering study program, at Gadjah Mada University, Indonesia. He is active in research activity and experimental engineering.



Rizal Justian Setiawan. He obtained his A.Md.T and B.Ed. in Mechanical Engineering from Yogyakarta State University, M.M. in Marketing Management from Universitas Terbuka, and MSc in Industrial Engineering at Yuan Ze University. Currently, he is an active student in the M.A in College of Law and Politics at National Chung Hsing University and an entrepreneur in appropriate technology manufacturing.



Darmono. He is a lecturer at the Faculty of Engineering, Yogyakarta State University. He was appointed as a lecturer at the university with a scientific

concentration in Civil Engineering and Planning Education. He obtained his education degree such as Drs., Ir., and Dr. at Yogyakarta State University. Then, he obtained M.T. degree at Gadjah Mada University.



Syukri Fathudin Achmad Widodo. He is a lecturer in the Mechanical Engineering Education department at Yogyakarta State University, Indonesia. He possesses expertise in the field of mechanical engineering education and dedicates his/her career to teaching and conducting research in that area.



Sumantri Sri Nugroho. He is an experienced Technical Engineer working at the Appropriate Technology Development Center in the D.I. Yogyakarta. He possesses profound expertise in the field of engineering and applies his knowledge to the development of appropriate technology.



Nur Evida Khosyati. She is an active student in the culinary technology education study program, culinary technology and fashion education department of Yogyakarta State University, Indonesia. She is active in research activity and experimental engineering.



Nur Azizah. She is a researcher from Sriwijaya University. She obtained S.Ked and M.D. degree at Sriwijaya University. Currently a student in the International Public Health (M.P.H) program at China Medical University, Taiwan (R.O.C).